

Radio Gateway — Link LMR Radios, LTE Radios, IP Radios, IP Phone Systems and More



Ensures Cooperative Information Sharing Across Systems and Devices

The VE-PG4 is a versatile RoIP (Radio over IP network) gateway unit, which seamlessly interconnects LMR radios, LTE radios, IP communication terminals, IP phone systems and external devices. In addition to the IP Network (LAN/WAN), the built-in LTE module* provides virtually nationwide communication coverage.

* Service availability depends on the country. Network coverage provided by a custom SIM card.



Communication Links

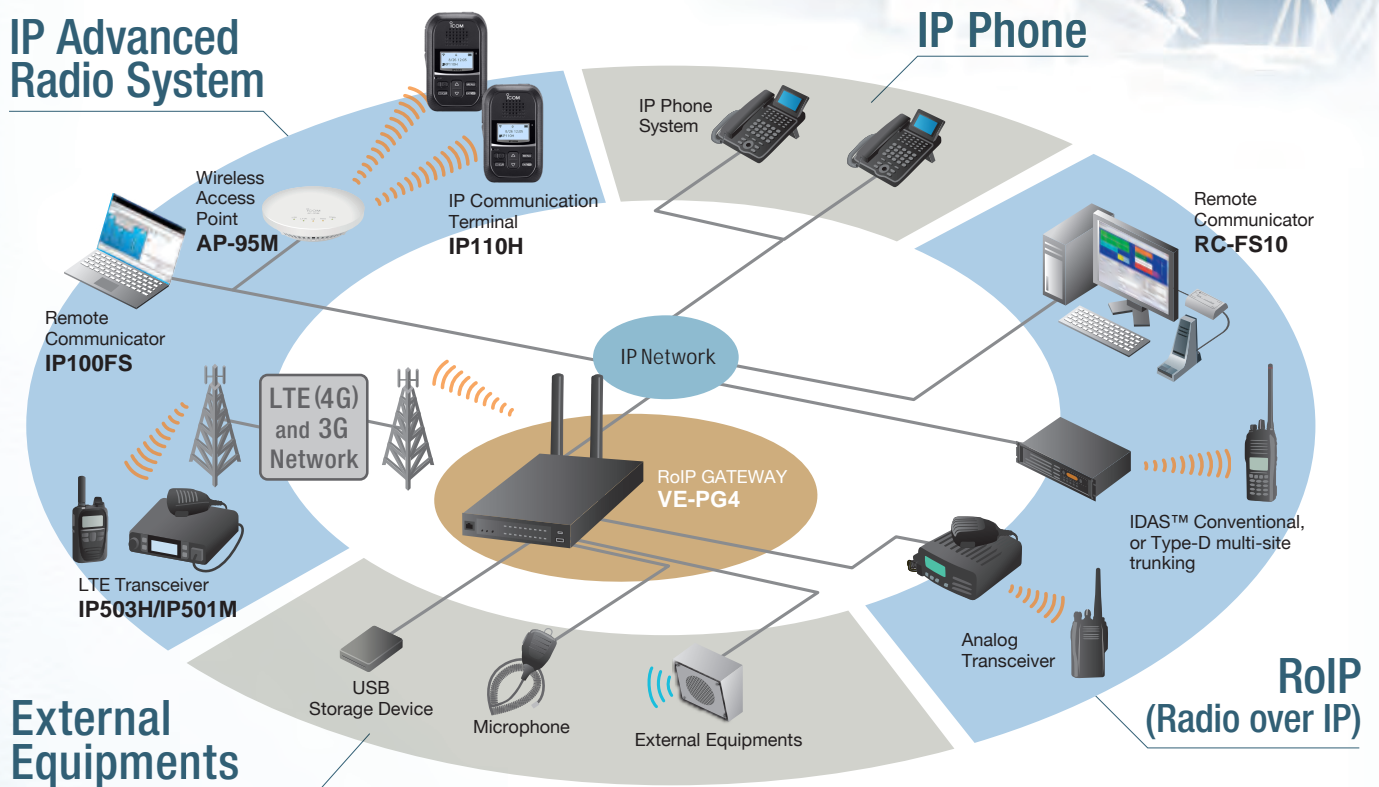

RoIP GATEWAY
VE-PG4

Features

All in One Package

The VE-PG4 includes built-in RoIP, SIP gateway, IP router, IP PBX and IP communication terminal controller functions, in one box. In comparison with a similar system combining several devices, installation and administration of the integrated VE-PG4 can be simpler, with less conflict of settings.

Call Recording to a USB Drive

Incoming/Outgoing calls can be recorded to an external USB device connected to the VE-PG4. Up to four recording settings are programmable. The recording call type is selectable from All, Group, and Individual calls. In addition, the Monitor function transfers the received audio data to an intended device.

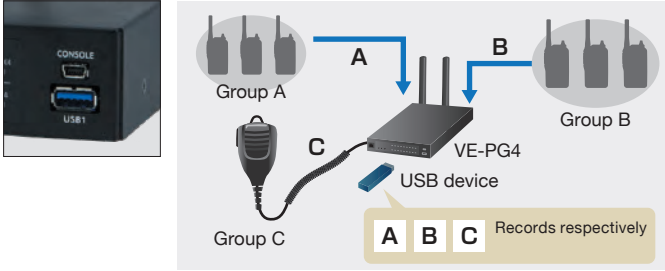

Microphone Connection for Base Operation

Connect HM-241, optional speaker-microphone to the microphone connector on the VE-PG4's front panel to enable simple base operation. Echo canceller and noise canceller functions are built-in for full-duplex communication with IP advanced radio system, like the IP110H, IP503H or IP501M.



Position and Status Information

GPS position and status information from the IP503H/IP501M LTE transceivers can be received and transferred to a PC to track the location of the radio users or a user in a vehicle.

* GPS mapping software is required for GPS data.

Remote Communicator Software, RC-FS10

The optional RC-FS10 remote communicator creates an IP-based virtual radio on a PC, and can communicate with land mobile radios, LTE radios, and IP communication terminals through the VE-PG4.



Serial Pass-through Function

The Serial Pass-through function enables you to connect a serial device to the VE-PG4 to extend the communication range between the connected device and a controller PC. The virtual serial port software for Windows® PC is supplied with the VE-PG4.

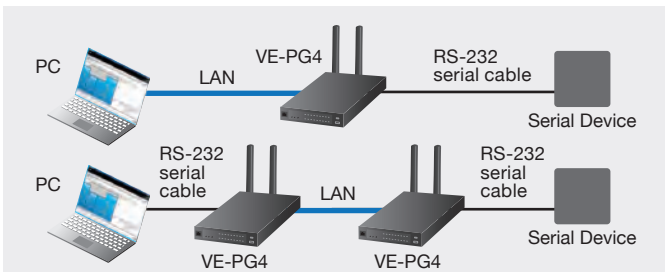

SIP Server and IP-PBX Functions

The built-in simple SIP server enables you to assign IP phone numbers with extension groups. The VE-PG4 can be connected to external SIP server as a client. The following IP-PBX settings are programmable.

- Voice Phonebook
- DID (Direct Inward Dialing)
- Used with Panasonic KX-UT and KX-HDV series IP phones
- Call log
- Extension presence
- Phone number routing
- Outside line regulations
- Caller prioritization
- External call limiting
- SIP conferencing

Router Functions with VPN Tunnel

The VE-PG4 supports LAN, DHCP client, Static IP or PPPoE connections. The VPN function creates a secure IP tunnel connection over the Internet.

Half-width 1U Form Design

The VE-PG4 occupies only half the width of a 19-inch rack. It can be functionally installed with repeaters, switching hubs and other equipment. LTE (4G)/3G antenna bases with 1.5 m (4.9 ft) of cable are supplied in case antennas need to be relocated for better reception.



Online Firmware Update

The VE-PG4 supports automatic and online firmware update functions, for remote maintenance. Settings can be saved to a backup file, and easily restored.

Management Features

- SYSLOG and SNMP
- Telnet and SSH
- Ping Test and Traceroute Test
- Abnormal condition monitoring, such as LAN port link-down and SIP server registration error
- Administrator password
- SNTP server
- Security slot

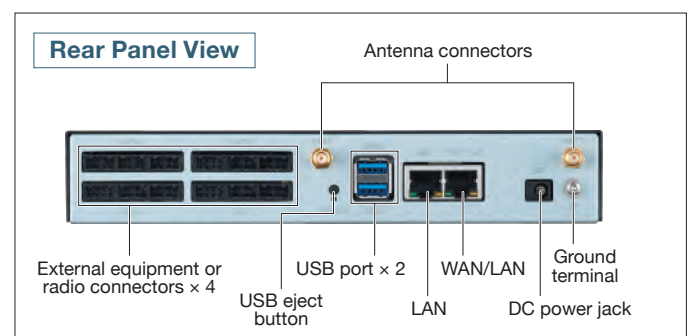

Built-in Controller for the IP110H, IP Communication Terminal (Wireless LAN)

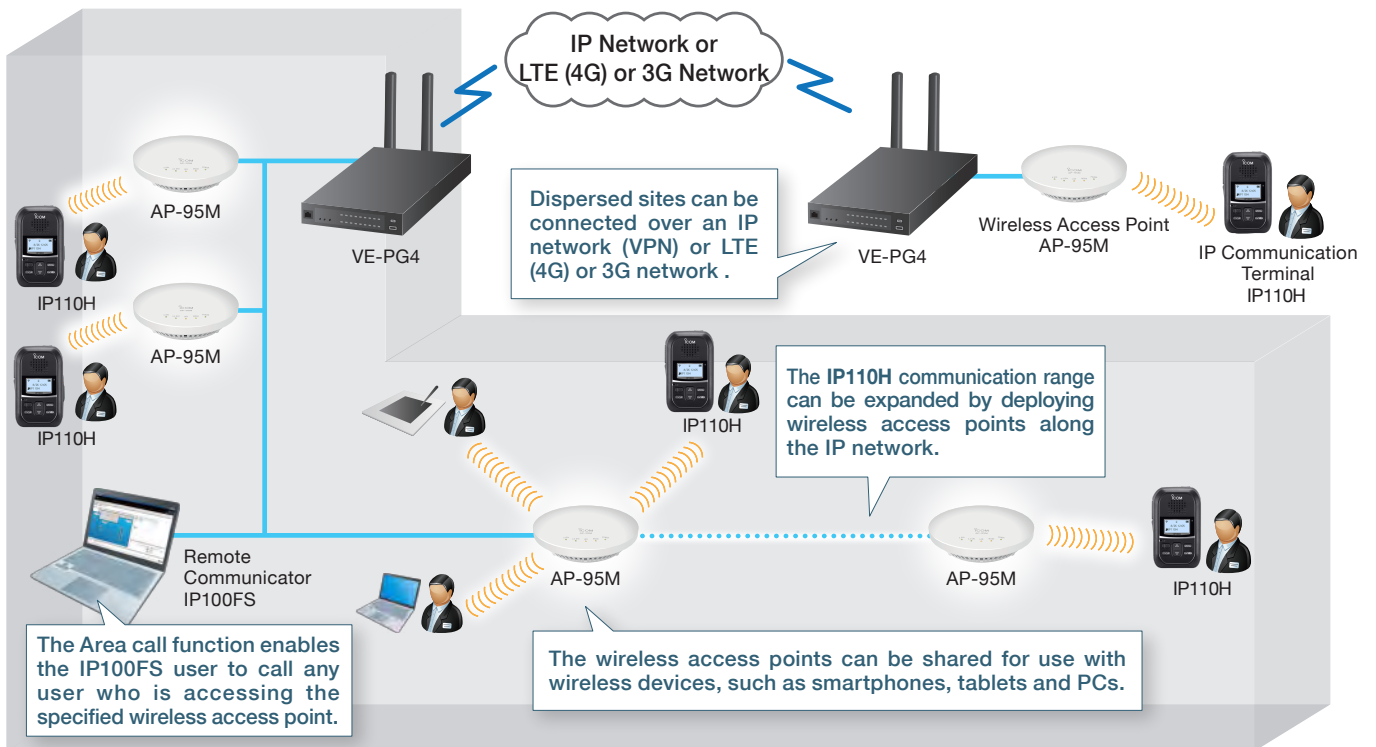

The VE-PG4 has a built-in IP110H IP communication terminal controller function that is capable of controlling up to 50 IP110H IP Communication Terminals, and IP100FS Remote Communicators. The IP110H can send and receive voice and preprogrammed text messages to the other units through the wireless LAN access points. The IP communication terminals are suitable for intra-building communication, which will communicate anywhere your network has Wireless LAN access.

Wireless Communication System

By deploying access points along the existing IP network, the IP advanced radio system can communicate from anywhere in the facility. The IP110H can access the nearest access point, and can roam between access points. No license fee is required, and there are no call charges.

Hands-free, Full-duplex Communication

With an optional earphone-microphone or headset*, the IP110H user can simultaneously talk and receive like a phone call. Hands-free operation allows your staff to carry out other tasks at the same time.

* For full-duplex operation, use either an HM-153LS, HM-166LS, or HS-102 with the OPC-2359, for full-duplex operation.

Individual, Group, All or Area Communication

Staff spread across multiple rooms can communicate seamlessly. The IP communication terminal can receive Short Data Messages with a vibration alert from a PC installed with a IP100FS.

Easy System to Set Up and Use

The VE-PG4 programs almost all terminal configurations over the air. Individual PC programming through a cable connection is not required. (Except initial setup).

IP Communication Terminal IP110H



- All, Group, Talkgroup, Individual and Telephone Calls
- 1000 mW loud audio from internal speaker
- Optional Bluetooth® headset, VS-3
- IP67 / IP54 waterproof and dust-tight
- Battery can be charged through the USB Type-C™ cable
- More than 20 hours of operating time (Tx 1: Rx 1: Stand-by 8 duty ratio)
- WPA2, WPA-Enterprise security

Remote Communicator IP100FS

(Supplied with USB flash drive for use as a USB hardware key)

- The IP100FS can communicate with IP110H IP communication terminals from a PC
- The IP100FS can obtain location information of each IP110H based on the access point being used
- Can be installed on a Windows® based tablet PC, as well as a laptop PC

Wireless LAN Access Point AP-95M

- IEEE 802.11ac (Wave 2) standard, high-speed communication
- Beam forming function, MU-MIMO function
- Optional RS-AP3, access point management software



AP-95M

Bridge Connection between Radio Systems

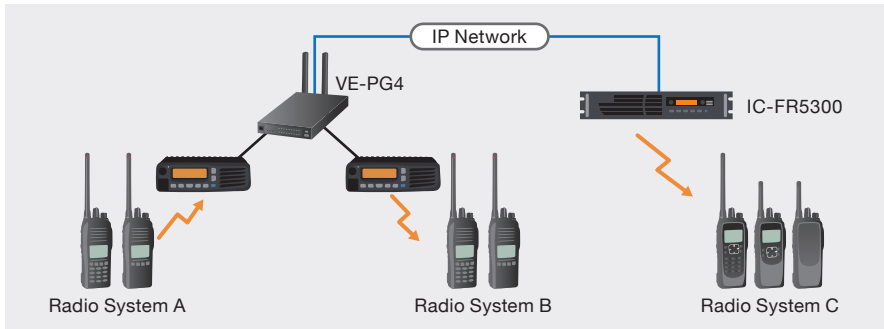

The VE-PG4 interconnects with two or more radio systems, even when the systems are using different bands and different categories. All received audio is bridged to opposing radio system, so a radio user can talk to all connected radio users. The built-in digital voice converter converts analog audio to IDAS™ compatible digital audio.

* Cross band/cross category operation may be prohibited in some countries. Please check the legal requirements in your country before installation.

LTE Transceiver Gateway

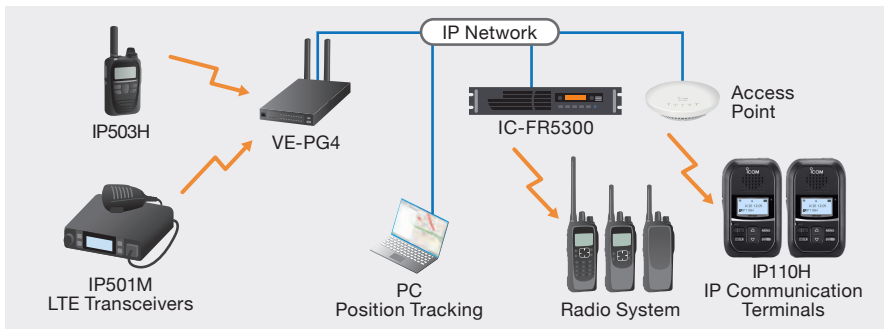

By installing a custom SIM card to the built-in LTE module, the VE-PG4 can interconnect IP503H/IP501M LTE transceivers with conventional radio systems and IP10H IP communication terminals. GPS position information from the LTE transceivers can be received and transferred to a PC.

IP Phone Interconnect

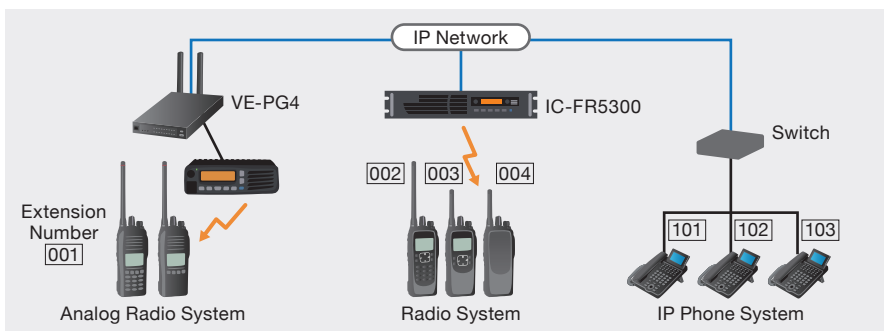

The built-in Simplified SIP server can assign extension numbers to IDAS™ radio terminals, IP advanced radio terminals, and groups of analog radio users as well as IP phones. A radio user can initiate phone calls. Phone users can make individual or group calls to connected radio users.

Multi-site Connection between VE-PG4s

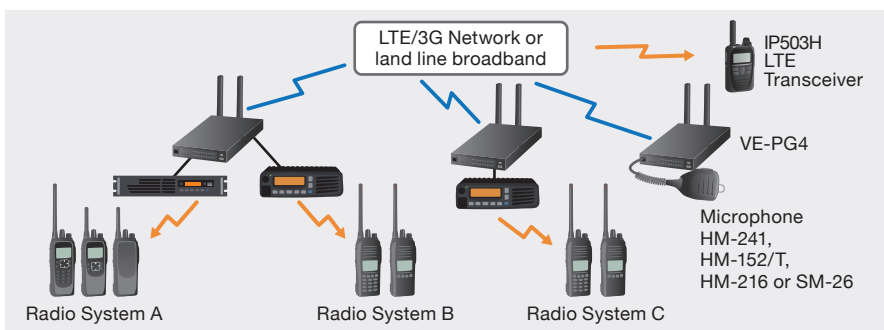

Two or more VE-PG4s can be connected through LAN or LTE (4G) and 3G networks. The communication area can be flexibly expanded, and dispersed radio sites can be connected, regardless of distance or radio system used.

External Equipment Connection

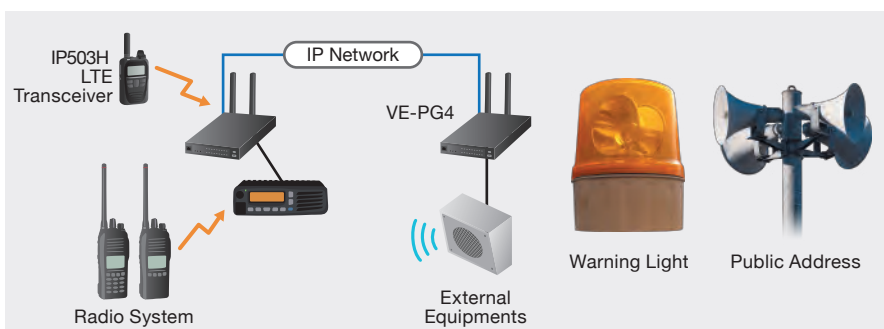

Public address system, siren, warning light and other external devices can be connected to the VE-PG4. When detecting an emergency signal, users can start emergency notification from either a digital transceiver, IP transceiver or public address system.

SPECIFICATIONS

GENERAL	
Power supply	12 V DC $\pm 10\%$, 4 A maximum 100–240 V AC (with the supplied AC adaptor)
Operating temperature range	0 to +40°C, +32 to +104°F
Operating humidity	5–95% (At no condensation)
Dimensions (WxHxD) (Projections are not included)	213 x 36.8 x 270 mm, 8.4 x 1.4 x 10.6 in (Approximate)
Weight	1.8 kg, 4 lb (Main unit, approximate)
Regulatory compliance	FCC Part 15 Class B/ ICES003, Part22, Part24, Part27, EN301 489-1, EN301 489-19, EN301 489-52, EN301 908-1, EN301 908-2, EN301 908-13, EN303 413, EN62479, EN62311, EN62368-1
INTERFACE	
LAN/WAN	RJ-45 type x 1 (Auto MDI/MDI-X) 10BASE-T/100BASE-TX/1000BASE-T *WAN/LAN port selectable.
LAN	RJ-45 type x 1 (Auto MDI/MDI-X) 10BASE-T/100BASE-TX/1000BASE-T
USB	Host interface
	Console interface
Network*	4G bands:
	3G bands:
External port	Connectors
	Audio input
	Audio output
	Control input
	Control output

All stated specifications are subject to change without notice or obligation.
* Service availability depends on the country. Network coverage provided by a custom SIM card.

Supplied Accessories

- Antennas • Antenna bases with 1.5m (4.9 ft) cable
- BC-236, AC adapter • Quick connectors

OPTIONS



OPC-2390 5m (16.4ft) cable for the IC-FR5300/FR6300 series repeater. D-SUB 25-pin connector.
OPC-2275 5m (16.4ft) cable for a mobile transceiver such as IC-F5060D/F6060D series and IC-A120/E.
 RJ-45 modular plug connector with speaker plug.
OPC-2273 5m (16.4ft) cable for the IC-M605/EURO VHF marine transceiver. Waterproof 8-pin connector.
OPC-2276 5m (16.4ft) cable for external microphone and speaker, instead of the front panel.
OPC-2389 5m (16.4ft) cable for a serial device with RS-232 connector.



An external speaker (user supplied) is required to be connected to the VE-PG4 to hear received audio with these microphones.

COMPATIBLE MODELS

IP Communication Terminal  IP110H	Wireless LAN connection. (Access Point is required.)
LTE Transceivers  IP503H IP501M	LTE (4G) or 3G Network connection.
Satellite PTT  IC-SAT100	OPC-2412 cable is required.
VHF/UHF Repeater  IC-FR5300, IC-FR6300	Either UC-FR5300 (LAN) or OPC-2390 is required.
VHF/UHF LMR Transceivers 	Connection Cable required. Depending on versions.
VHF Marine Transceivers  IC-M605, IC-M605EURO	OPC-2273 cable is required.
VHF Air Band Transceivers  IC-A120, IC-A120E	OPC-2275 cable is required.

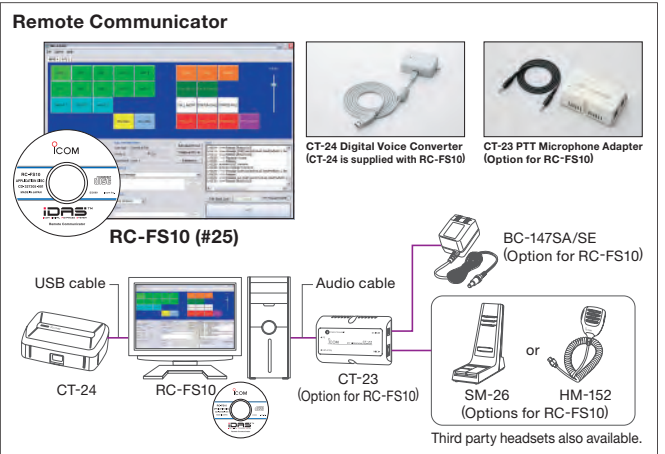

Icom, Icom Inc. and Icom logo are registered trademarks of Icom Incorporated (Japan) in Japan, the United States, the United Kingdom, Germany, France, Spain, Russia, Australia, New Zealand and/or other countries. IDAS and IDAS logo are trademarks of Icom Incorporated. Windows is either a registered trademark or a trademark of Microsoft Corporation in the United States and/or other countries. All other trademarks are the properties of their respective holders.

Icom (Australia) Pty. Ltd. Unit1,103 Garden Road, CLAYTON Victoria 3168 | Phone: (03) 9549 7500

www.icom.net.au

Icom America Inc.
www.icomamerica.com

Icom (Europe) GmbH
www.icomeurope.com

Icom (Australia) Pty. Ltd.
www.icom.net.au

Icom Canada
www.icomcanada.com

Icom Spain S.L.
www.icomspain.com

Icom Asia Co., Ltd.
www.icomasia.com

Icom Brazil
E-mail: sales@icombrasil.com

Icom (UK) Ltd.
www.icomuk.co.uk

Icom France s.a.s.
www.icom-france.com